

# Plastic Sheeting

**Its use for emergency shelter  
and other purposes**



**AN OXFAM TECHNICAL GUIDE**

**Prepared by  
Jim Howard and Ron Spice**

# **Plastic Sheeting**

**Its use for emergency shelter  
and other purposes**

**AN OXFAM TECHNICAL GUIDE**

**Prepared by  
Jim Howard and Ron Spice**

First published March 1973

Revised September 1977

Second revision February 1981

Third revision May 1989

© Oxfam 1989

### **British Library Cataloguing in Publication Data**

Howard, Jim 1926-

Plastic sheeting: its use for emergency housing  
and other purposes - 2nd ed.

1. Developing Countries. Residences. Building  
materials. Plastic sheeting.

I. Title II. Spice, Ron

691'.92

ISBN 0-85598-140-7

**Oxfam is a partnership of  
people committed to the  
relief of poverty, distress  
and suffering in any part of  
the world.**

**We believe in the essential  
dignity of people and in  
their capacity to overcome  
the problems they face  
whether they stem from  
natural, social, political or  
economic conditions.**

85/MJ/89

<b>Contents</b>	1	Introduction	<b>1</b>
	2	Types of flexible plastic sheeting available	<b>3</b>
	3	Properties of polythene sheeting	<b>5</b>
	3.1	General properties	<b>5</b>
	3.2	Mechanical properties	<b>6</b>
	3.3	Thicknesses	<b>6</b>
	3.4	Colours	<b>7</b>
	3.5	Sunshine degradation or weakening	<b>8</b>
	3.6	Thermal properties of film-covered structures	<b>9</b>
	3.7	Condensation in film-covered structures	<b>11</b>
	4	Structures covered with plastic films	<b>13</b>
	4.1	General points	<b>13</b>
	4.2	Semi-cylindrical structure	<b>14</b>
	4.3	Ridge tent structure	<b>16</b>
	4.4	The Oxfam temporary shelter	<b>22</b>
	5	Use of plastic sheeting in combination with traditional construction materials	<b>27</b>
	6	Details of manufacturers	<b>29</b>
	7	Appendices	<b>33</b>
	I	Useful data for water storage	
	II	Precipitation data	
	III	Other useful data	
	IV	A guide to prices of polythene sheeting and accessories	



# 1

## **Introduction**

This technical guide arises from Oxfam's experience of using considerable quantities of plastic sheeting in disaster situations. It has been prepared to help field staff and others understand the properties of these sheeting materials with a view to successful emergency shelter construction.

Plastic sheetings are now widely used in a variety of structures, with a satisfactory degree of reliability. This is demonstrated by the large areas of greenhouses covered with plastic film to be seen in the UK and elsewhere, and the great number of semi-permanent plastic-clad farm buildings used for farm stock, mushroom growing and storage.

Polythene or, more correctly, polyethylene sheeting is now readily available in many parts of the world in large quantities and various grades and qualities. In addition to its use for shelter, it can be used for storage, tank linings, tarpaulin-type covers, groundsheets, food containers, crop protection, inflated-walled houses, irrigation and soil mulching.

## **Environmental Protection**

We would like to emphasise the importance of protecting the environment from careless or indifferent management of plastic sheeting materials. Although these materials can be used with great effect for the purposes intended, they can also be a major form of trash and litter in urban or rural situations. Some plastic materials are biodegradable, however most will deteriorate with age and exposure to sunlight and disintegrate. It is essential that every effort should be made to control the distribution of plastic sheetings, and that cuttings and other plastic waste and garbage, should be gathered up and utilised or disposed of in an appropriate manner in the given conditions.

<b>Description</b>	<b>Reinforcing</b>	<b>Eyelets</b>	<b>Area m x m</b>	<b>Thickness/gauge</b>	<b>Unit wt.,kg</b>	<b>Unit size as stored m x m x m</b>
<b>Black rolls</b>	No	None	8 x 28	1500	77	2.29 x 0.265 x 0.265
<b>Black rolls</b>	No	None	8 x 28	1000	52	2.14 x 0.25 x 0.25
<b>Black tarpaulins</b>	Yes	At 475mm centres all round	4 x 7	1000	9	2.14 x 0.25 x 0.25
<b>Green tarpaulins</b>	Yes	W	4 x 4	1000	5	
<b>Dark green tarpaulin rolls</b>	Yes	At 950mm centres down long sides	4 x 50	1000	61	2.12 x 0.265 x 0.265
<b>Green tarpaulin rolls</b>	Yes	W	4 x 48	1000	59	2.12 x 0.25 x 0.25

Table 1 Examples of polythene sheeting used by Oxfam for emergency shelter.

# 2

## **Types of flexible plastic sheeting available**

Most plastic materials such as polythene, polyvinyl chloride (PVC), nylon, terylene, polypropylene, etc. can be produced in the form of thin, flexible sheeting. Also available are several kinds of flexible sheeting reinforced with a square mesh of natural or synthetic fibres to give greater strength and resistance to tearing. Such reinforcement increases the cost and weight per unit area. The maximum seamless widths of 1000 gauge (250 micron or 0.25 mm) sheeting available are 4 metres reinforced and 8 metres with no reinforcing. Wider sheets have to be fabricated by stitching or heat sealing. The reinforced sheeting is available with ready-fixed eyelets in various spacings and configurations.

Most of this guide relates to polythene sheeting. However, all the techniques discussed will work equally well with any flexible plastic sheeting that is available on site.



# 3

## **Properties of polythene sheeting**

### **3.1 General properties**

Polythene sheeting has many advantages when compared to other flexible materials that can be used as waterproof membranes. The chief advantages are its low cost and weight per unit area. It is available from the manufacturers in standard seamless sheeting up to 8 metres wide in 1000 gauge or 1500 gauge (250 and 375 microns). Its properties are as follows:

- a. Resistance to water. It is completely waterproof and has a very low moisture vapour permeability.
- b. Chemical resistance. It is unaffected by salts, dung- urine and most agricultural chemicals. Petrol and lubricating oils may cause swelling by absorption and should not be stored in contact with the sheeting.
- c. Ageing and weathering. Polythene sheeting cannot mildew or rot in store and it is unaffected by moisture. Clear sheeting deteriorates slowly in sunshine and the progressive loss of strength and flexibility may become apparent after a period of from 12 to 15 months. Black sheeting, however, is resistant to sunlight and is recommended for most outdoor uses where light transmission is not essential.
- d. Thermal properties. The sheeting is flexible down to temperatures well below freezing point. It melts at 115° C (239° F), i.e. above the boiling point of water, but starts to soften and lose tensile strength at above 80° C (175° F)

### **3.2 Mechanical properties**

As a buried membrane, the main properties required of any plastic material can be listed as follows:

- a. Flexibility, for ease of installation and to conform to minor undulations of the excavated base.
- b. Toughness, to remain undamaged during the installation process and subsequent 'backfilling' operation.
- c. Durability, to retain its physical properties when buried.
- d. Resistance to attack by soil fauna.
- e. Resistance to extremes of temperature.

Polythene is an inert material; it will not rot even if buried in fertile soil and is not readily attacked by rodents or insects (although termites have been known to eat it and obviously polythene will not provide a barrier to determined rats or mice). Polythene film will not deteriorate during storage although clear films must be stored in shade.

### **3.3 Thicknesses**

Polythene films are made in thicknesses ranging from 12 microns (50 gauge) to 1000 microns (4000 gauge). Cost per unit area is proportional to thickness.

Polythene sheeting is available from UK, Continental and American manufacturers in seamless widths of up to 8 metres in 1000 gauge and in seamless widths of 17 metres in 500 gauge. For ease of transport this wide

sheeting is normally folded twice at the factory so that it can be rolled on to a cardboard core. Thus, 8 metre wide seamless sheeting is rolled on a 2 metre wide core. The weight of 1000 gauge sheeting is approximately 0.25 kg per square metre.

Polythene films are marginally stronger in the machine direction (along the length of the film) than in the transverse direction.

Unreinforced polythene film of 1000 gauge is tough enough to withstand wind stresses adequately if correctly fixed to structures. (Most of the greenhouse acreage already mentioned is covered with film of 500 gauge. The 50 kg sacks used to transport fertilisers and other chemicals are usually made from 800 gauge sheeting and some farmers use cut open plastic sacks for simple farm buildings such as calf housing.)

Polythene is the cheapest flexible plastic material; for example, rolls of sheeting 8 metres x 28 metres would cost the UK farmer about £55 in 1000 gauge or £105 in 1500 gauge, at 1988 prices.

For emergency housing purposes films thinner than 500 gauge would be unsuitable and it is recommended that 1000 or 1500 gauge should be used.

### **3.4 Colours**

The two most common colours are natural (clear or translucent) and black-pigmented. However, a wide range of colours are available including red, blue, green and white.

### **3.5 Sunshine degradation or weakening**

Clear plastic deteriorates fairly quickly in strong sunlight, although coloured polythenes are far less susceptible to degradation due to sunshine, with darker colours being more resistant and black extremely resistant.

All transparent plastic films are slowly weakened by continuous exposure to sunshine. The durability of clear films intended for use outside can be considerably increased by adding chemicals called 'ultra-violet light absorbers' during manufacture. Such 'ultra-violet light inhibited' films currently commercially available last for at least two years when continuously exposed to sunshine on greenhouse structures in the UK and it would be reasonable to expect at least a one-year life from them even in countries like India. Ultra-violet light inhibited films often have a slight yellow or green colour which is due to the nature of the absorbing chemical used.

An interesting and important observation from Oxfam's field operations is that in locations with long sunshine periods, at high temperatures the degradation of reinforced plastic sheeting can be accelerated when such sheetings are directly exposed to sunlight. The reinforcing material, whether this be metal wire, nylon or some plastic substance, can cause 'hot spots' within the sheeting and these temperature differentials cause local damage - brittleness or laminating - which reduces the structural strength of the sheeting material.

To a lesser degree this same 'hot spot' problem arises where polythene film is stressed over any structure which will absorb and hold heat, such as metal tubing. Film in contact with this hot structure will weaken more quickly for any given amount of ultra-violet light radiation than film at

air temperature. Ways of providing the necessary protection are:

- a. Using a black polythene adhesive tape on the outside of the polythene cover, so that it protects the sheet itself from sunshine in this critical area (black polythene film is almost completely resistant to ultra-violet light degradation).
- b. Painting the film with aluminium or bitumastic paint at those points where it is in contact with the structure.
- c. Using anti-hot spot foam tape.

### **3.6 Thermal properties of film-covered structures**

Black films expand when the sun shines and contract at night. The actual expansion factor is 1% per 38° C (100° F) temperature change. Thus, a black plastic skin fitted to a structure when the sun is shining will become drum-tight after nightfall; allowance should be made during construction for this expansion and contraction. Clear films do not absorb heat energy from the sun and stay at ambient temperature; consequently the expansion/contraction rate can generally be ignored.

The thermal insulation properties ('U' factor) of polythene films are poor. However, well-insulated buildings can be made by using two sheets of plastic between which is sandwiched an insulating material. In the UK some very satisfactory mushroom-growing houses have been made in this way, using fibreglass or mineral wool as an insulant. In Italy, farm buildings have been made in the same manner, using two layers of plastic with straw as an

insulant. Any lightweight, dry material which contains a lot of air spaces would be suitable. If an organic material like straw or hay is so used it would be desirable to pre-treat it with an insecticide.

If the temperature within any plastic-clad structure becomes too high in sunshine it can be reduced by spraying the outer surface with aluminium or light-coloured paint. Even a lime-wash or thin mud slurry might give temporary protection in extreme circumstances. Some paints do not adhere very well to polythene surfaces, and may need to be replaced after a period of time.

Alternatively, a special polythene netting can be used over the sheeting to provide partial shade. Netting can also be used on its own to provide some protection against wind and sun in situations where some air movement and subdued light is desirable.

Living conditions in an emergency shelter covered with white, green or blue film might be more agreeable than in structures clad with clear or black film; day temperatures would certainly be more equable as emergency housing shelters clad with plastic film will tend to be hot when the sun shines and cold at night.

The fire hazards to the occupants of a structure covered with a single skin of polythene are minimal; the film melts at temperatures in excess of 100° C (212° F).

However, this is not true where two layers of plastic are used with a straw or hay inner filling. Clearly, the risk of ignition from cooking, lighting or cigarettes is much higher. It is essential that the fire risks and danger are appreciated by the users of the structures.

### **3.7 Condensation in film-covered structures**

When the temperature inside the shelter is greater than that outside, condensation may form on the inner surface. This may be caused by dampness in the soil and in this case the amount of condensation forming can be reduced by using a polythene film 'carpet' on the floor of the shelter to help prevent evaporation from the soil. Condensation can also be caused by cooking or by the drying of wet clothes inside a structure. Increased ventilation can help to reduce condensation caused in these ways.



# 4

## **Structures covered with plastic film**

### **4.1 General points**

Any plastic structure intended for emergency housing must:

- a. offer shelter from the weather;
- b. be stable in wind;
- c. not be unbearably hot in daytime.

Choice between different films as a covering will depend on:

- a. availability;
- b. expected life of the shelter;
- c. prevailing climatic conditions.

The circumstances in which any emergency and locally available structural materials are used will obviously vary greatly. It would therefore be unhelpful to be dogmatic in these notes, which are intended for general guidance only.

There are three problems in supported polythene structures, namely:

- a. erection of the framework;
- b. securing the plastic to the framework;
- c. securing the plastic to the ground.

An obvious but extremely important rule with polythene structures is to prevent the polythene pressing against sharp or rough points which could initiate tearing. Thus, contact areas between sheeting and other materials should be free of sharp edges and points and be as large as possible to minimize stresses.

## 4.2 Semi-cylindrical structure

A semi-cylindrical structure covered with plastic film is commonly used for greenhouses in the UK. The basic structure is shown in Figure 1. Because the plastic is stretched tautly over a curved surface no stress points exist and no flapping should occur in the wind. The dimensions of the framework have to be tailored to suit the plastic film available and to the method used for securing the film to the ground.

Figure 1. Framework for plastic greenhouse

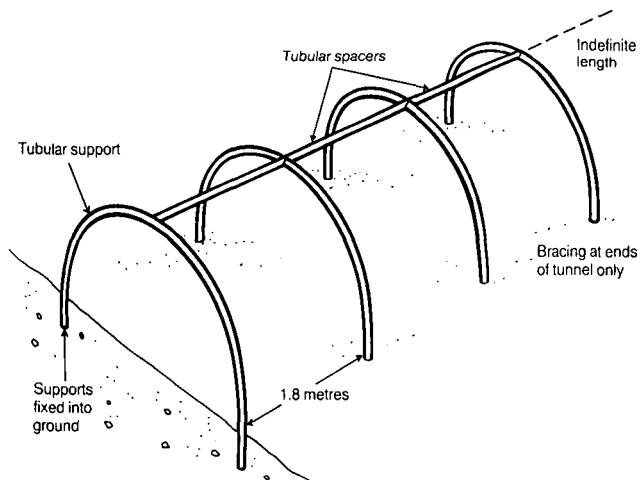

One possibility is that rolls of 8m width black polythene without eyelets or reinforcing might be available (see Table 1). In this case it might be most appropriate to secure the sheeting by burying its edges in the ground. Methods of

doing this are described later, but about 800mm should be allowed for this purpose on each side (Figure 2). The remaining width will be sufficient to cover a semi-circle of 4.3m diameter (D) and 2.15m height (H). The length of curved pole required for each arch, allowing for 300m in the ground on both sides, is 7.35m.

Figure 2. Cross section of plastic greenhouse

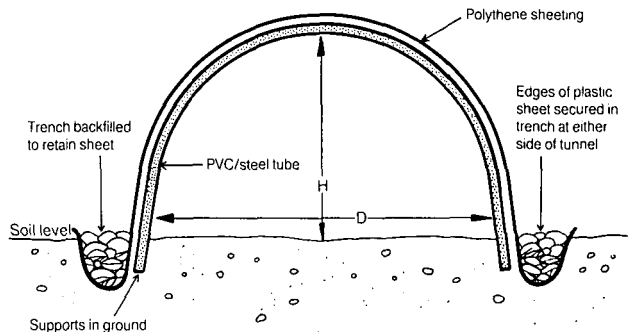

Another possibility is that rolls of 4m width green reinforced tarpaulins and tentpegs are available. In this case two 4m rolls could be joined at the highest point of the structure using the built-in eyelets. Securing the sheeting to the ground with tent pegs through the other eyelets will allow the full 8m width to be used for cover.

In the UK, suitably curved steel tubing is used for the framework. If this is not available quickly in a disaster area, PVC rigid tube can be utilized. PVC rigid tube arches smoothly, returns to its original straightness, is relatively cheap, lightweight and easy to transport. The ridge of a structure made of PVC tubing could be joined to

the hoops using standard Tee-piece pipe fittings (Figure 3). The plastic sheeting is attached only to the end hoops. The end hoops should be braced with guy ropes.

Figure 3. Use of 'Tee' pieces to make greenhouse ridges from PVC pipes

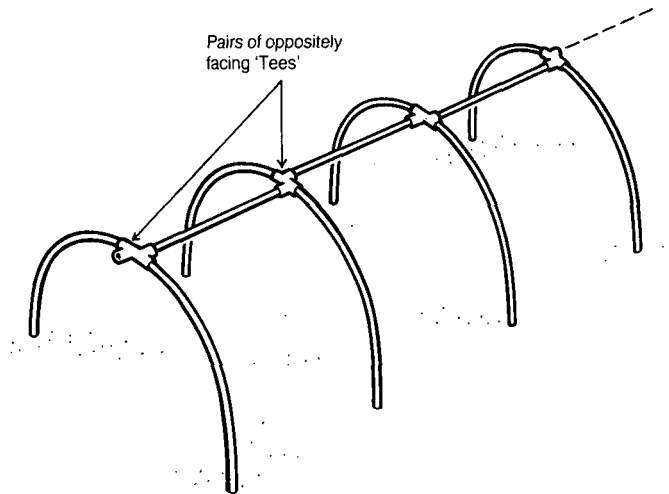

#### 4.3 Ridge tent structure

The ridge tent type of structure can probably be made faster and with less special materials than other types of emergency shelter. Basic shelters can be made by driving two posts firmly into the ground, stringing a rope tautly across them and hanging a sheet of plastic between the posts, burying its edges in shallow trenches the width of the tent apart (Figure 4).

Figure 4. Basic shelter using rope as a ridge

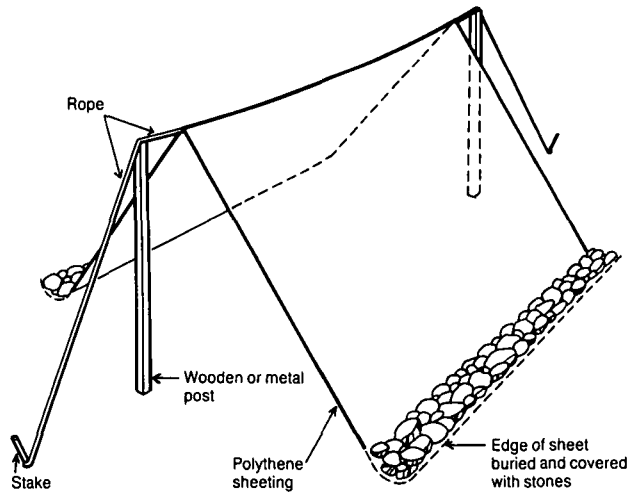

A more durable ridge tent can be constructed by spanning the upright posts with a metal or wooden ridge pole. If the materials available to make ridge poles are not sufficiently strong to span the entire length of the tent, then intermediate uprights can be used (Figure 5). The stability of this type of structure will depend upon the rigidity of the ridge and the anchoring of

Figure 5. Simple plastic covered shelter with intermediate uprights

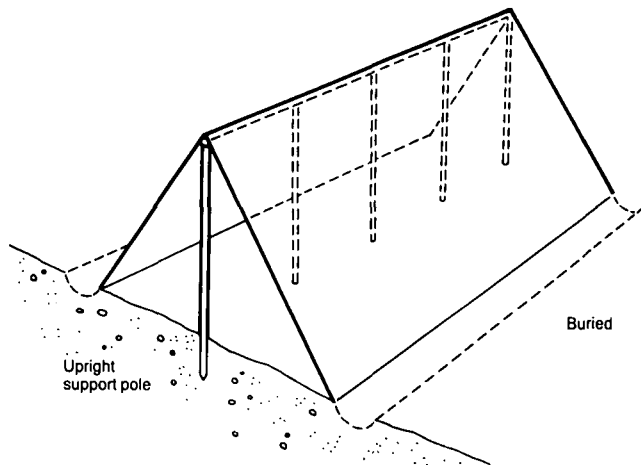

the sheeting at soil level. Figures 6, 7 and 8 illustrate techniques for securing the ridge using round pole timber, tube steel and angle iron as the ridge pole

Figure 6. Detail of apex of ridge using bush pole as the ridge

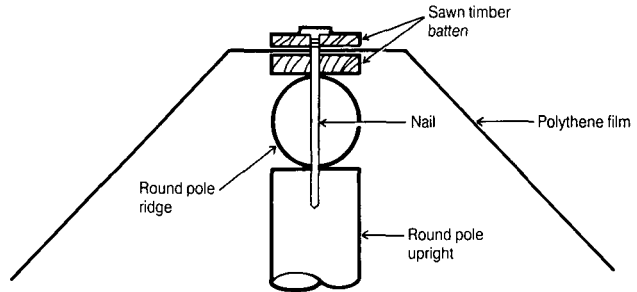

Figure 7. Fixing film to tubular metal ridge

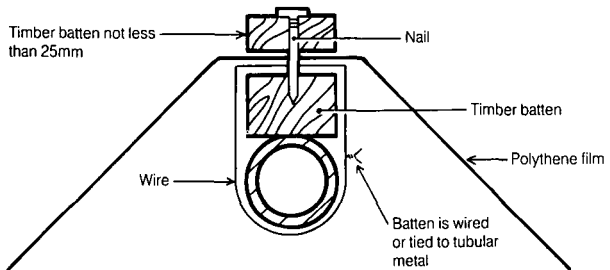
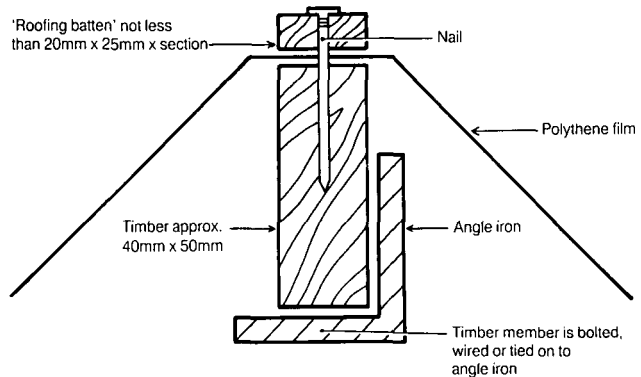

Figure 8. Fixing film to angle iron ridge



The ridge poles should be as free of protrusions or irregularities as possible to avoid tearing the plastic and are most simply fixed to the uprights by means of nails. Rather than having these nails pierce the plastic directly, it is preferable to sandwich the film between the ridge pole and a short upper piece of sawn timber which will resist tearing better. If sufficient sawn timber is available, a piece the full length of the ridge pole could be used and nailed at several points. Obviously, sharp edges or rubbing points on these lengths of sawn timber should be avoided.

The simplest method of anchoring the sheeting to the ground is to dig a shallow trench and bury the length of sheeting. However, in areas with strong winds or with sandy soils which do not easily grip polythene, this is unlikely to prove adequate. Figures 9, 10 and 11 show methods of improving the anchorage between the polythene and the soil. The techniques illustrated in Figures 9 and 10 have the disadvantage of burying quite long lengths of sheeting, with the result of reducing the effective coverage of the tent.

Figure 9. Using stones to secure plastic at ground level

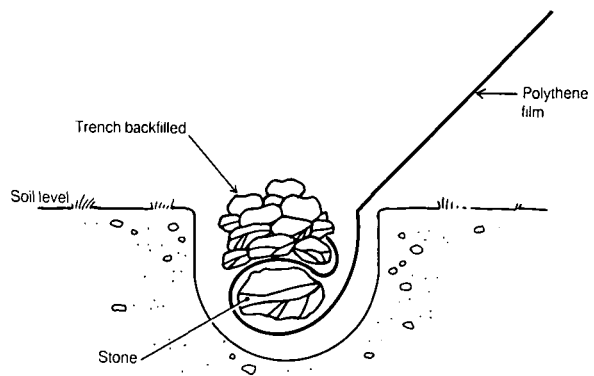

Figure 10. Using timber to secure plastic at ground level

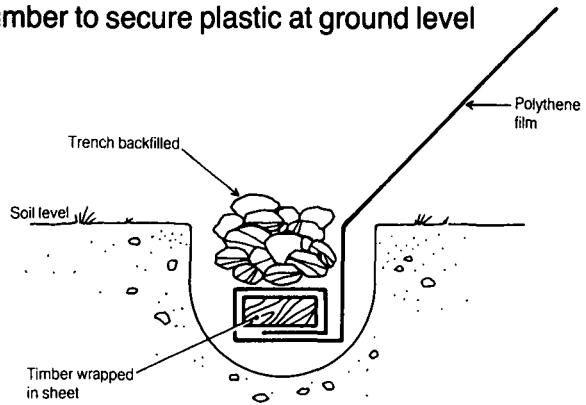
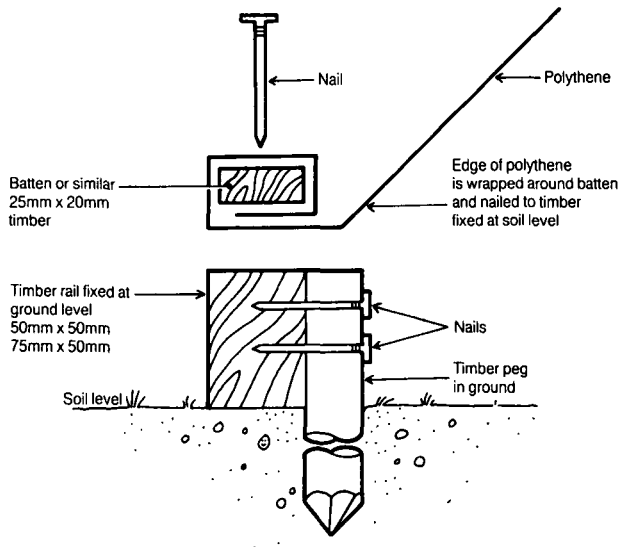

Figure 11. Securing plastic at ground level using sawn timber



Alternatively, where available, tent pegs can be used; however, they will require special reinforcing eyelets to prevent the sheet tearing. Some plastic sheetings are manufactured with eyelets built in at various centres (see Table 1). When sheeting materials need to be fitted with eyelets in the field, these can be supplied separately. They come in two pieces and are fixed through sheeting materials either by using a mandrel and die, or, for the snap-and-fix 'ARRO' eyelets, simply by hammering.

Sheet materials should be double thickness, if possible, at eyeletting points. The material should be folded back from the edge, say 100mm, before inserting the eyelet.

If no other fixing methods are available, sheeting can be secured by tying a knot in the corner of a sheet (like tying a knot in a handkerchief) and, if necessary, tying a rope around the knot as shown in Figure 12.

Figure 12. Use of knot for securing plastic

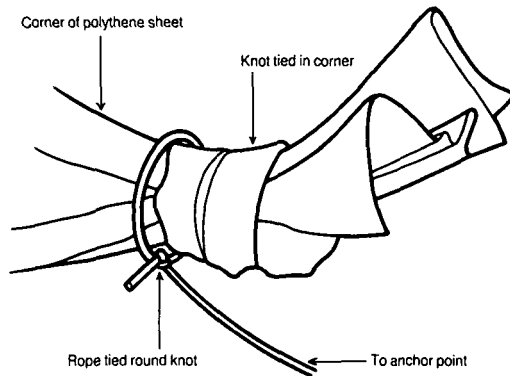

Where high winds are anticipated, the location and orientation of the shelters should take account of likely wind direction. In addition some of the following measures should be taken:

- a. The use of guy ropes, good practice in all circumstances, is essential in areas with strong winds.
- b. Any available netting material placed over the plastic sheeting will help to reduce wind damage.
- c. Where available, reinforced polythene sheeting should be used for the main body of the tent as its far greater resistance to tearing makes the additional expenditure worthwhile.

d. Special polythene mesh can be used as a wind break, normally as a free standing barrier in front of a line of tents. (Thin polythene mesh material is commonly used in Europe to protect crops or prevent snow drifting on exposed hillsides.)

Where very cold conditions are experienced people using emergency shelters sometimes excavate part of the floor area within the tent to provide a sleeping space free from draughts.

#### **4.4 The Oxfam temporary shelter**

The Oxfam Technical Unit have designed a simple ridge tent, in kit form, based on polythene sheeting and tubular steel, to allow a rapid response to the need for durable temporary shelters in emergency situations (Figure 13).

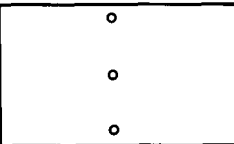
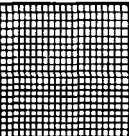
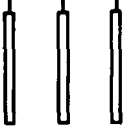
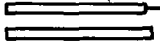



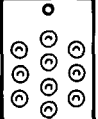

Figure 13. The Oxfam Temporary Shelter



The advantages of the kit are its ease of handling and transportation, simple erection, durability and low cost (£60 in 1988 in the UK).

The tent's framework consists of a 4m steel ridge pole supported at its ends and mid-point by 2m high steel tent poles and secured by guy ropes. One sheet of reinforced plastic goes over the ridge pole and is pierced by the tent poles through reinforced eyelets. A second square sheet of reinforced plastic is cut diagonally and each half used to make doorways to close the ends of the tent. The items making up this kit are listed in Table 2.

Table 2 Kit list of Oxfam temporary shelter

ITEM	QUANTITY
	7 metre x 4 metre reinforced black plastic sheeting <b>1</b>
	4 metre x 4 metre reinforced green plastic sheeting <b>1</b>
	2 metre long x 25mm diameter metal tent poles <b>3</b>
	1.9 metre ridge poles male and female <b>2</b>
	40 metre guy rope <b>1</b>
	Wooden guy adjustment block <b>6</b>
	450mm guy rope pegs (18") <b>6</b>
	250mm tent pegs (10") <b>10</b>
	Card of 10 eyelet reinforcements <b>1</b>
	Accessories bag <b>1</b>

The tent is large in size, with a floor area of 16 square metres, and can in an emergency sleep 16 adults, although it is more suited to a family unit of 6 to 10 persons plus belongings. The unit weight of the kit is 25kg.



The Oxfam Temporary Shelter





# 5

## **Use of plastic sheeting in combination with traditional materials**

Plastic sheeting can be used in combination with traditional construction materials to great effect. Plastic sheeting will considerably improve the resistance to wind and rain of traditional construction methods while traditional materials such as grasses and earth can help overcome the poor insulation properties associated with polythene structures. In this way semi-permanent, as opposed to temporary, shelters can be constructed. A fine example is in Southern Sudan, where traditional racubas (hemispherical structures made from a timber framework covered with reed or grass matting or any other suitable material available) have been considerably improved by the use of plastic sheeting sandwiched between the inner timber framework and an outer layer of empty sacks and cardboard. The use of sheeting was of particular importance in this instance as the grass and reeds, traditionally used, were in short supply.

In Bangladesh and India plastic sheeting has been used in conjunction with bamboo matting in a very successful way. Several thousand houses have been built using plastic sheeting as a waterproof and windproof membrane sandwiched between an inner and outer woven bamboo mat (Figure 14).

Figure 14. Plastic and bamboo matting house, Bangladesh





# 6

## **Details of Suppliers of polythene sheeting Manufacturers**

Monarflex Ltd  
Lyon Way  
Hatfield Road  
St Albans  
Herts AL4 0LQ

Anaplast Ltd  
Lundholm Road  
Ardeer  
Stevenston  
Ayrshire KA20 3NQ

Calnay Ltd  
Maerdy Industrial Estate  
Rhymney  
Gwent NP2 5XQ

British Visqueen Ltd  
Yarm Road  
Stockton-on-Tees  
Cleveland TS18 3RD

Zedcor Marketing Ltd  
Bridge Street Mill  
Bridge Street  
Witney  
Oxon OX8 6LJ

## **Suppliers of reinforced polythene tarpaulins**

Monarflex Ltd  
Lyon Way  
Hatfield Road  
St Albans  
Herts AL4 0LQ

**Suppliers of polythene lay-flat tubing and polythene bags**

Zedcor Marketing Ltd  
Bridge Street Mill  
Bridge Street  
Witney  
Oxon OX8 6LJ

**Suppliers of polypropylene rope**

Monarflex Ltd  
Lyon Way  
Hatfield Road  
St Albans  
Herts AL4 0LQ

**Makers and suppliers of eyelets and wooden tent rope runners**

The North Face (Scotland) Ltd  
PO Box 16  
Industrial Estate  
Port Glasgow  
Scotland PA14 5XL

**Makers and suppliers of tent poles and pegs**

Allvic Engineering Co  
Elm Crescent  
Kingston-upon-Thames  
Surrey KT2 6HL

**Makers and suppliers of adhesive tapes for  
polythene sheeting**

DRG Sellotape Products  
Elstree Way  
Borehamwood  
Herts WD6 1RU

Gawler Plastics  
Unit 2  
Northavon Business Centre  
Dean Road  
Yate  
Bristol BS17 5NH





## Appendices Appendix I Useful data for water storage

1 gallon of water	= 10 lb
1 cubic foot of water	= 6.25 gallons
1 cubic metre	= 1000 litres = 220 gallons
1 gallon	= 4,546 litres
1 litre of water	= 1 kilogram
1 cubic metre of water	= 1000 kilograms
1 cubic yard of water	= 764.6 kilograms
1 cubic yard	= 0.7646 cubic metres
1 cubic metre	= 1.308 cubic yards
1 square metre	= 1.196 square yards
1 hectare	= 2.47 acres

## Appendix II Precipitation data

1 mm of water	= 10,000 litre of water/hectare
1 inch of water	= 22,610 gallons/acre
1 inch of water	= 41/2 gallons/square yard
1 acre - inch	= 22,610 gallons
1 acre - foot	= 271,320 gallons
1 mm of water	= 1 litre of water/square metre
1 acre - 100 mm	= 405 cubic metres = 89,000 gallons
1 hectare - 100 mm	= 1,000 cubic metres = 220,000 gallons
1 hectare - inch	= 254 cubic metres = 55,880 gallons

## Appendix III Other useful data

1,000 microns	= 1 millimetre = 0.039 inches
1 metre	= 1,000 millimetres = 3.28 feet
1,000 gauge	= 0.25 millimetres = 0.01 inches
1 US gallon	= 0.83 Imperial gallons = 3.76 litres
1 kilogram	= 2.2 pound Avoirdupois

#### **Appendix IV A guide to prices of polythene sheeting and accessories (1988)**

Black non-reinforced 1000 gauge	£0.23/sq. metre
Black non-reinforced 1500 gauge	£0.46/sq. metre
Black reinforced 1000 gauge	£0.76/sq. metre
Green reinforced 1000 gauge with built-in eyelets	£0.95/sq. metre
'ARRO' snap-and-fix eyelets	£82.00 per 1000
Oxfam temporary shelter	£60.00 per kit

**Airfreight** - as a rough costing use £1.50 per kilogram for transporting quantities of plastic sheeting.

**This book has been prepared by :**

**The Technical Unit  
Oxfam House  
274 Banbury Road  
Oxford OX2 7DZ  
Tel: (0865) 56777  
Fax: (0865) 57612  
Telex: 83610**







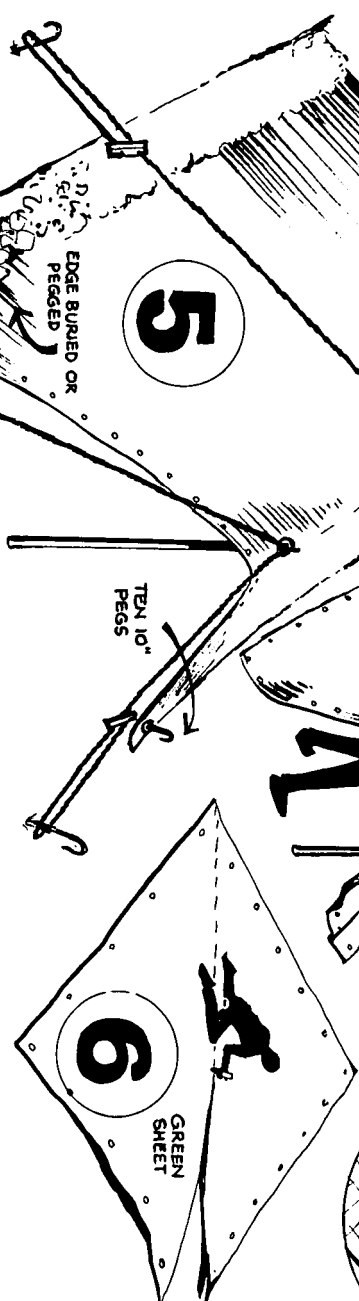

6 GUY ROPES  
6 18" PEGS

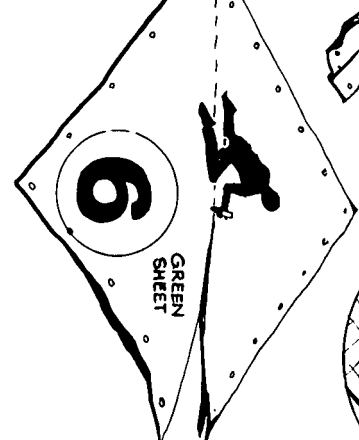
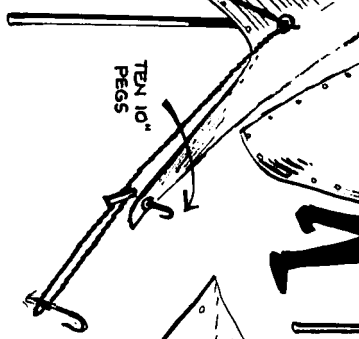

DOORWAY  
EACH END



# TEMPORARY SHELTER

## Assembly Instructions

